

グレーチング付集水枳

グレーチング付集水枳 (T-25)

◆寸法図

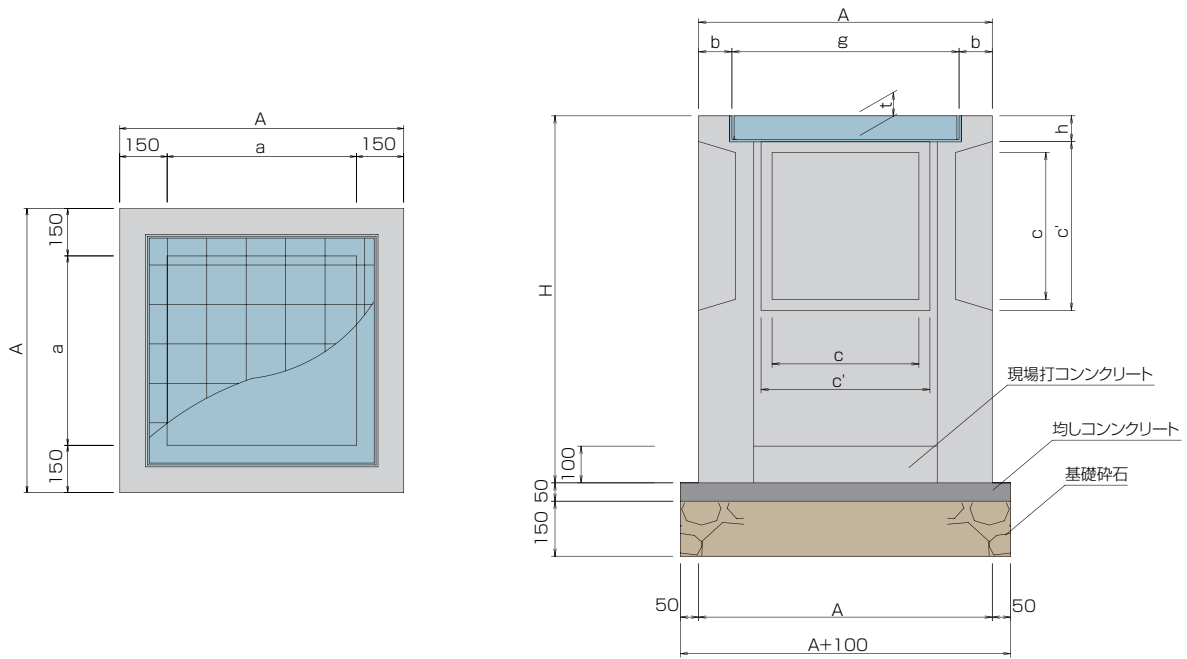

◆寸法表 グレーチングはボルト固定が標準です。

単位：mm

名称	H	a	A	b	c	c'	g	h	t	参考重量(kg)								
SM-40	400	400	700	95	400	460	501	70	55	186								
□400	500									225								
	600									325								
○標準	700									404								
	800									483								
	900									562								
	1000									641								
	1100									720								
	1200									799								
SM-50	500									500	800	90	400	460	607	70	65	297
□500	600																	385
	700																	466
○標準	800	560																
	900	654																
	1000	748																
	1100	842																
	1200	936																
	1300	1030																
	1400	1124																
	1500	1218																

名称	H	a	A	b	c	c'	g	h	t	参考重量(kg)
SM-60	600	600	900	87	400	460	713	70	75	471
□600	700									579
	800									706
	900									814
○標準	1000									922
	1100									1030
	1200									1138
	1300									1246
	1400									1354
	1500									1462
M-70	700									700
□700	800	563								
	900	614								
	1000	734								
	1100	854								
	1200	974								
	1300	1094								
	1400	1214								
	1500	1334								
M-80	800	800	1100	82	800	860	925	100	90	581
□800	900									638
	1000									695
	1100									830
	1200									964
	1300									1098
	1400									1232
	1500									1366
M-100	1000	1000	1300	86	1000	1060	1115	100	100	753
□1000	1100									825
W150	1200									944
	1300									1110
	1400									1276
	1500									1442
	1600									1608
	1650									1691
M-100	1000	1000	1400	137	1000	1060	1115	100	100	968
□1000	1100									1048
W200	1200									1214
	1300									1444
	1400									1674
	1500									1904

※W:側壁厚

グレーチング付集水桝

◆300×400×685 参考重量458kg

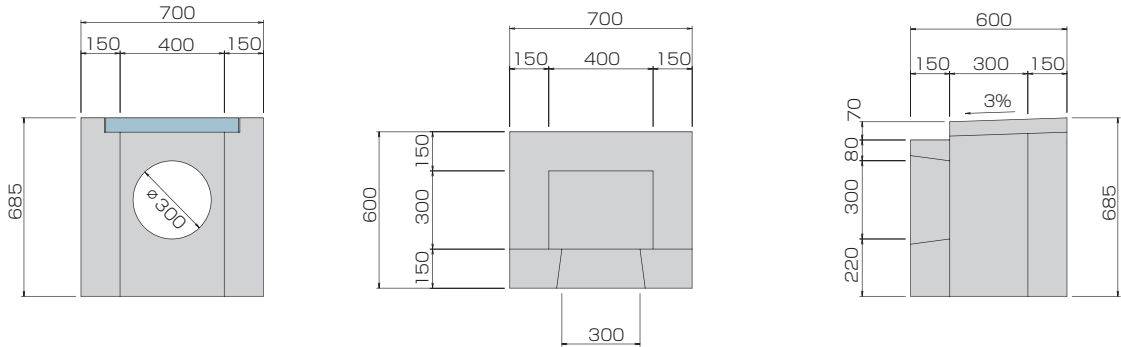

◆熊本市型 参考重量175kg

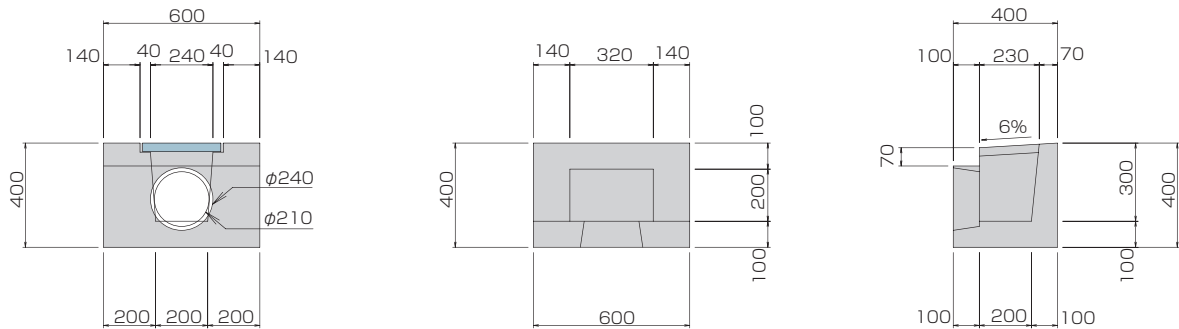

◆300×400×H600
参考重量202kg

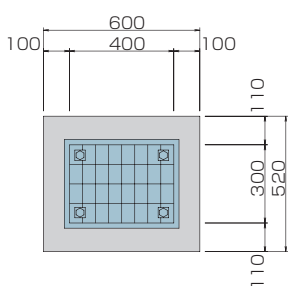

※グレーチングは110° 開閉式も有ります。

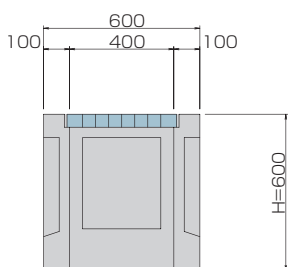

◆300×400×H700
参考重量210kg

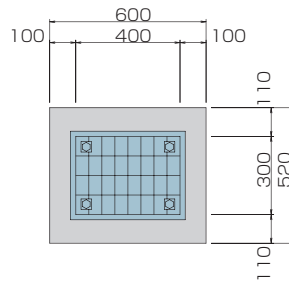

※グレーチングは110° 開閉式も有ります。

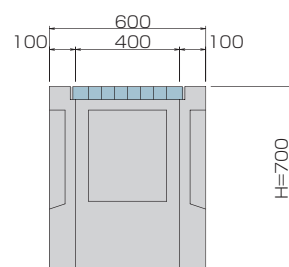

◆300×400×H800
参考重量256kg

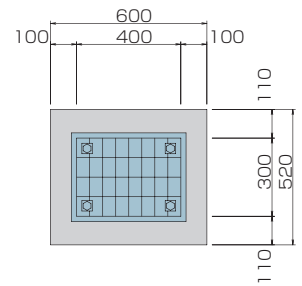

※グレーチングは110° 開閉式も有ります。

